

Female Header 2.0 mm 180° & SMT Series

SPECIFICATIONS

Current Rating: 2 A
 Insulator Resistance: 3000 MOhm min.
 Contact Resistance: 20 mOhm max.
 Dielectric Withstanding: AC 500 V
 Operating Temperature: -40°C ~ +105°C
 Soldering Temperature: 260°C for 3~5 sec. max
 Contact Material: Phosphor Bronze
 Insulator Material: Polyester, UL 94V-0
 Standard: Nylon-6T
 Finish: Tin, Gold or Duplex Plated
 Standard: Gold Flash all over
 Note: Duplex Plating: Gold Plated on contact area, Tin on solder area

F494-MGN-D060-XX

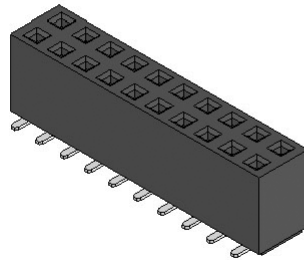

F494-SGN-D033-XX

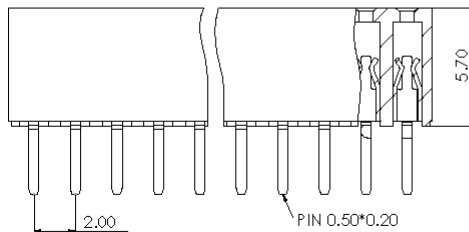
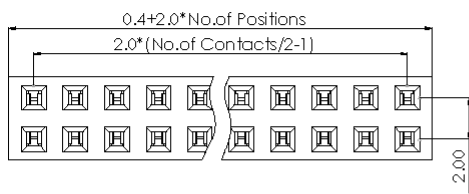
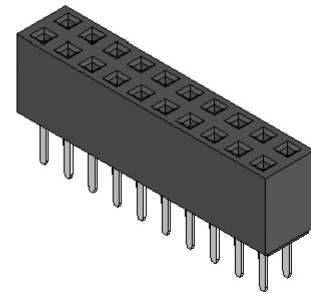

[F494]

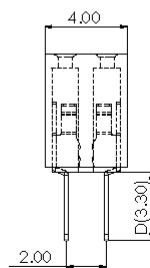
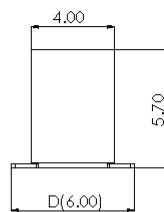

[F494]

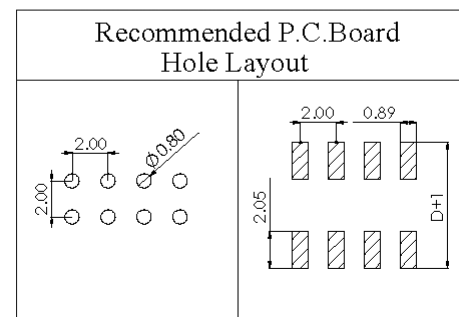
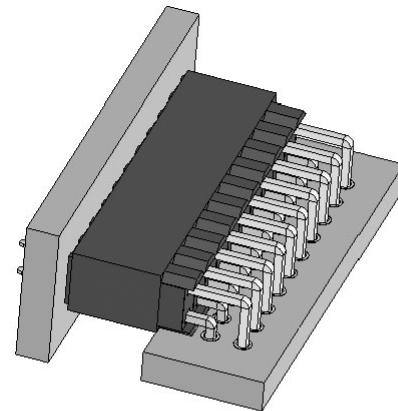

How to order

Unit: mm

Series	Connector Type	Contact Plating	Material	Pin Length mm	Number of Contacts
FXXX	- X	X	X	- DXXX	- XX
F494:F/H 2.00 H:5.70 Dual Row	S: Straight Type M: SMT Type	G: Gold Flash T: Tin Plated A: 10U" Gold B: 15U" Gold C: 20U" Gold ⊙ Duplex Plating D: Gold Flash/Tin (Standard: G)	P: PBT N: Nylon-6T (Standard: N)	S-D D033 M-D D060	(04 TO 80 Contacts)